

Teilleiste

Kennnummer	Bezeichnung	Artikelnummer
①	HLT Standfuß/Wandflansch	7595-7401-06-01
②	HLT Wandgelenk	7595-7401-02-01
③	HLT Aufsatzgelenk	7595-7401-01-01
④	HLT Drehwinkel	7595-7401-25-01
⑤	HLT Zwischengelenk	7595-7401-03-01
⑥	HLT Winkel	7595-7401-04-01
⑦	HLT Winkeladapter 48	7595-7401-16-01
⑧	HLT Winkelkupplung	7595-7401-08-01
⑨	HLT Winkelkupplung Schmalflansch	7595-7401-09-01
⑩	HLT Kupplung	7595-7401-05-01
⑪	HLT Kupplung Schmalflansch	7595-7401-07-01
⑫	HLT Kupplung 48	7595-7401-17-01
⑬	HLT Dreh- und Neigungskupplung	7595-7301-01-01
⑭	HLT Neigungsadapter 10°	7595-7401-10-01
⑮	HLT Neigungsadapter Schmalflansch 10°	7595-7401-11-01
⑯	HLT Neigungsadapter verstellbar	7595-7401-19-01
⑰	HLT Gehäuseadapter VESA	7595-7401-12-01
⑱	HLT Profilrohr	7595-7401-30-xxxx
⑲	HLT Rundrohr 48	7595-7401-40-xxxx
⑳	HLT Leuchtenadapter	7595-7401-15-01
㉑	HLT VESA 100 Adapterplatte	7595-7401-90-02
㉒	HLT Aufsatz-Drehlager	7595-7401-60-01
㉓	HLT Kompaktkupplung Schmalflansch	7595-7401-14-01
㉔	HLT Standfuß 48	7595-7401-26-01
㉕	HLT Standsäule	7595-7450-12-xxxx

Kennnummer	Bezeichnung	Artikelnummer
㉖	HLT Neigungsadapter verstellbar Schmalflansch	7595-7401-18-01
㉗	HLT Aufsatzgelenk vertikal	7595-7401-01-02
㉘	HLT Wandgelenk vertikal	7595-7401-02-02
㉙	HLT Leuchtenadapter 48	7595-7401-90-05
㉚	HLT Hubarm S	7595-760x-xx-01
㉛	HLT Hubarm L	7595-768x-xx-01
㉜	HLT Hubarm 48	7595-748x-xx-01

Aufbauvarianten HLT Tragarmsystem Deckenmontage

Deckenmontage vertikal

Variante V1 Variante V2 Variante V3

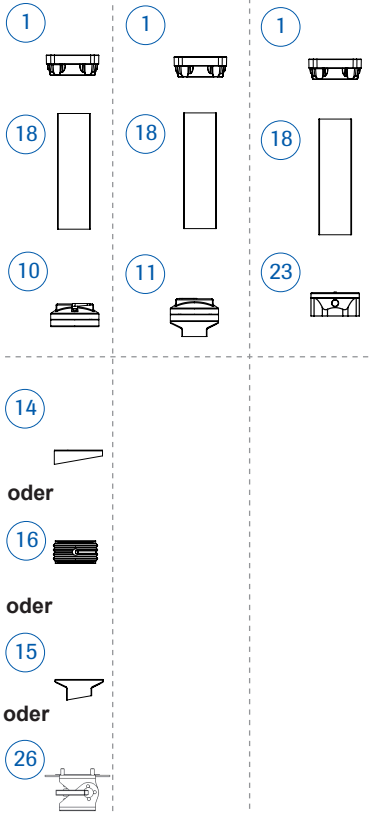

Deckenmontage horizontal

Variante H1

Variante H2

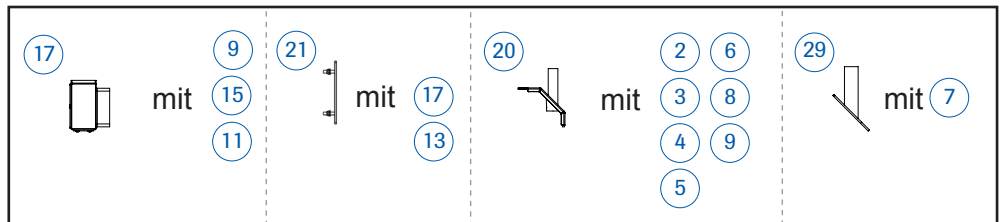
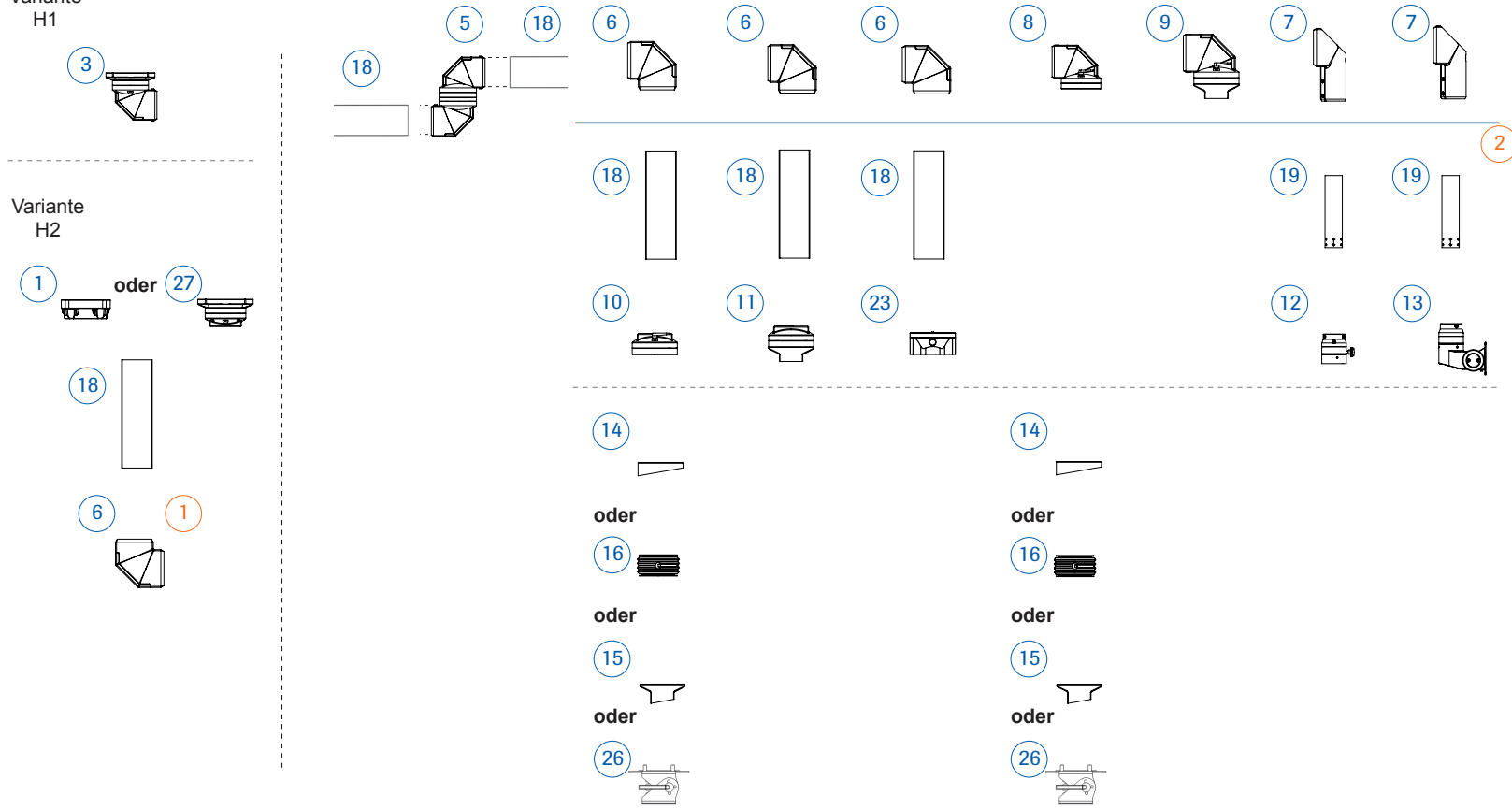

- ① **Achtung:** Bei Auswahl Winkel ⑥ kein Zwischengelenk ⑤ verwenden.
- ② **Achtung:** Alle Teile unter der Linie sind in die Traglast einzurechnen.

Aufbauvarianten HLT Tragarmsystem Aufsatzmontage

Aufsatzmontage vertikal

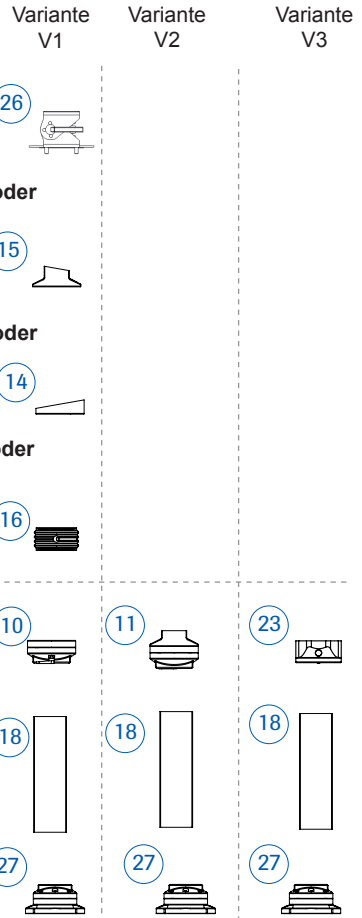

Aufsatzmontage horizontal

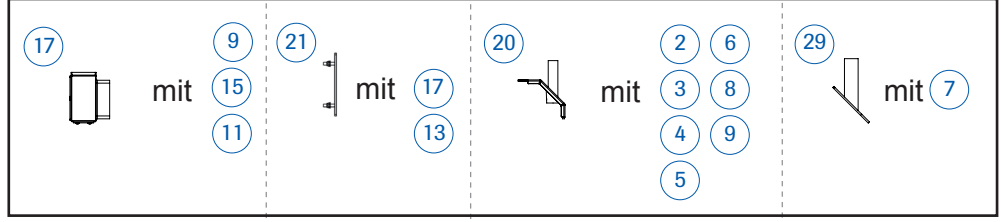
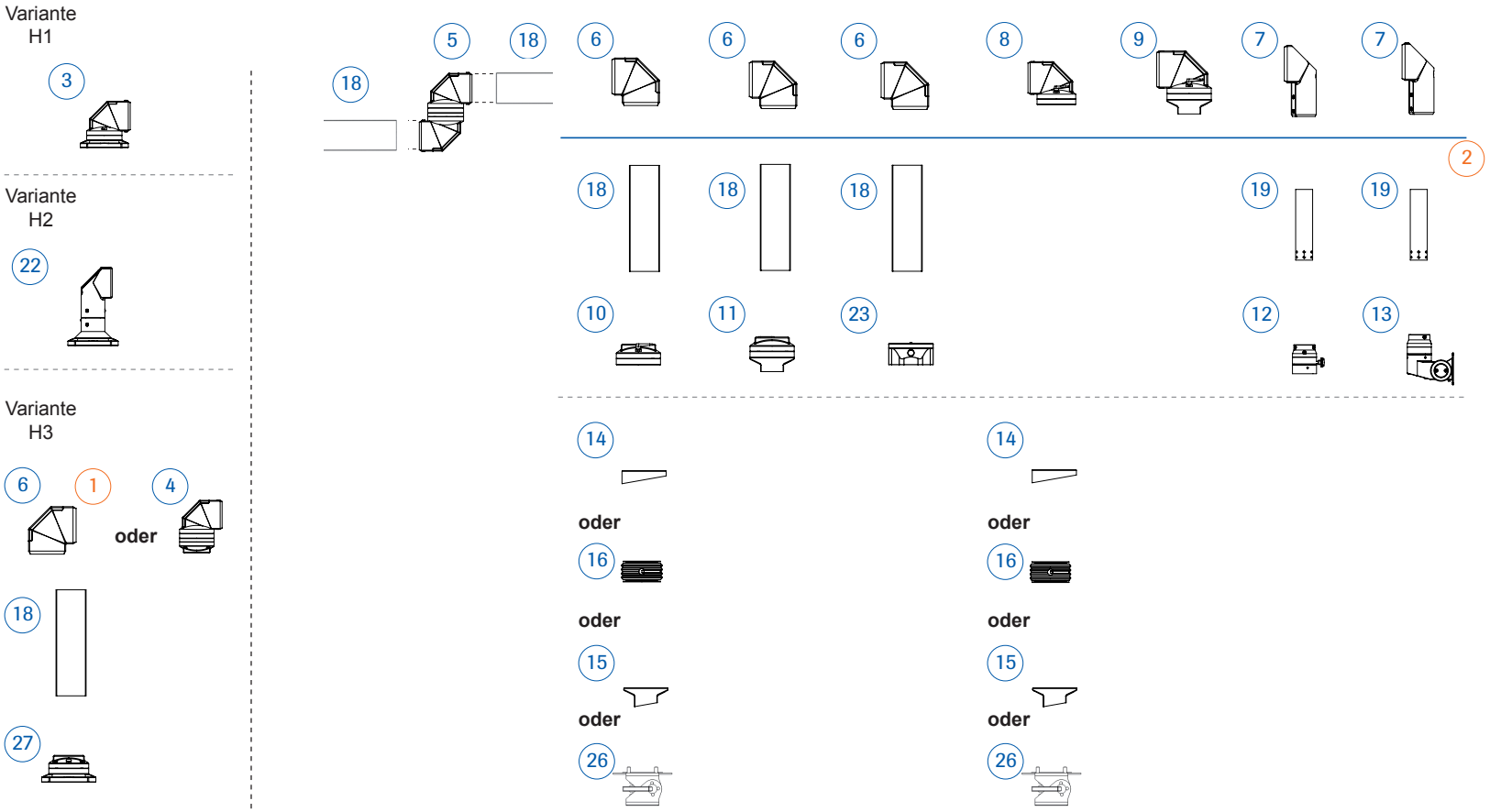

- 1** **Achtung:** Bei Auswahl Winkel **6** kein Zwischengelenk **5** verwenden.
- 2** **Achtung:** Alle Teile unter der Linie sind in die Traglast einzurechnen.

Aufbauvarianten HLT Tragarmsystem Wandmontage

Wandmontage vertikal

Variante V1 Variante V2 Variante V3



oder



oder



oder

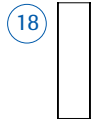
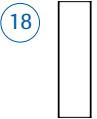
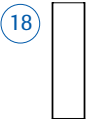

Wandmontage horizontal

Variante H1

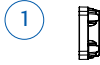

Variante H2

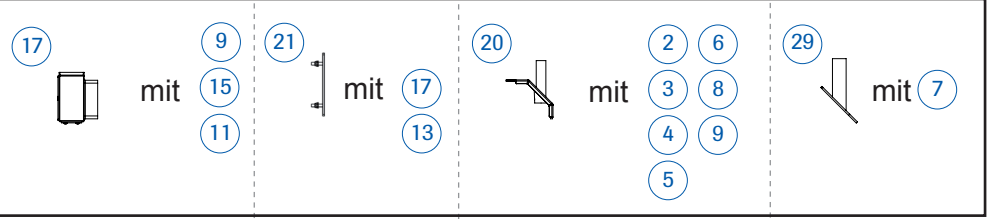
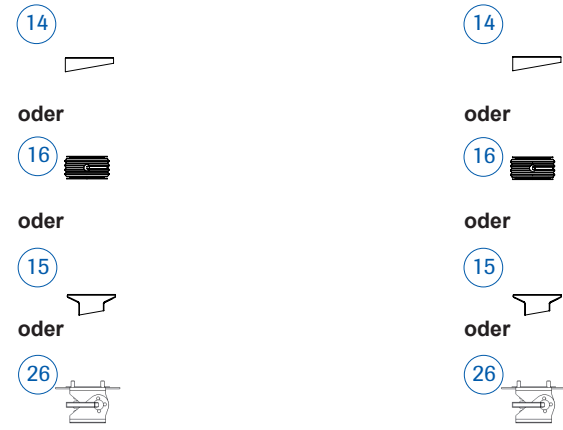
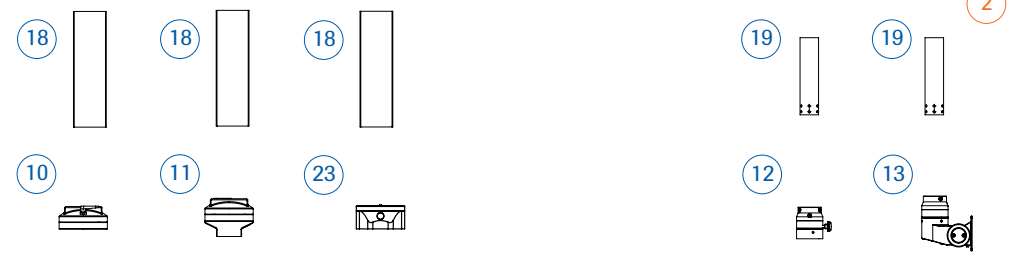
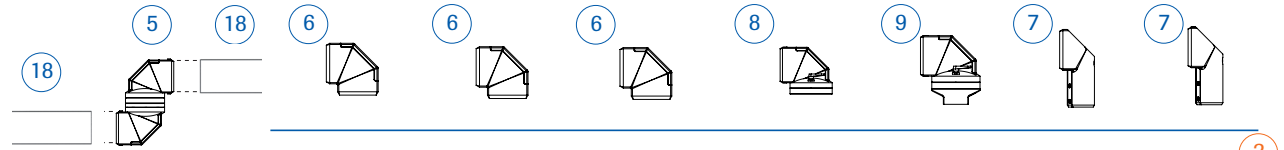
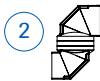

- 1 **Achtung:** Bei Auswahl Winkel 6 kein Zwischengelenk 5 verwenden.
- 2 **Achtung:** Alle Teile unter der Linie sind in die Traglast einzurechnen.

Aufbauvarianten HLT Tragarmsystem Bodenmontage

Bodenmontage vertikal

Variante V1 Variante V2 Variante V3 Variante V4

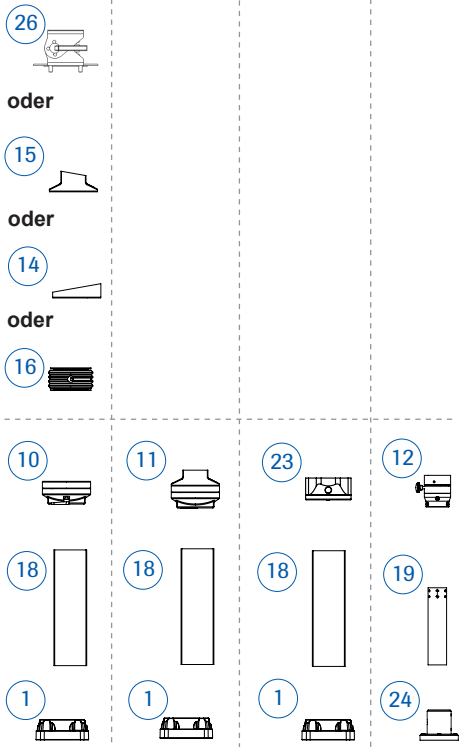

Bodenmontage horizontal

Variante H1

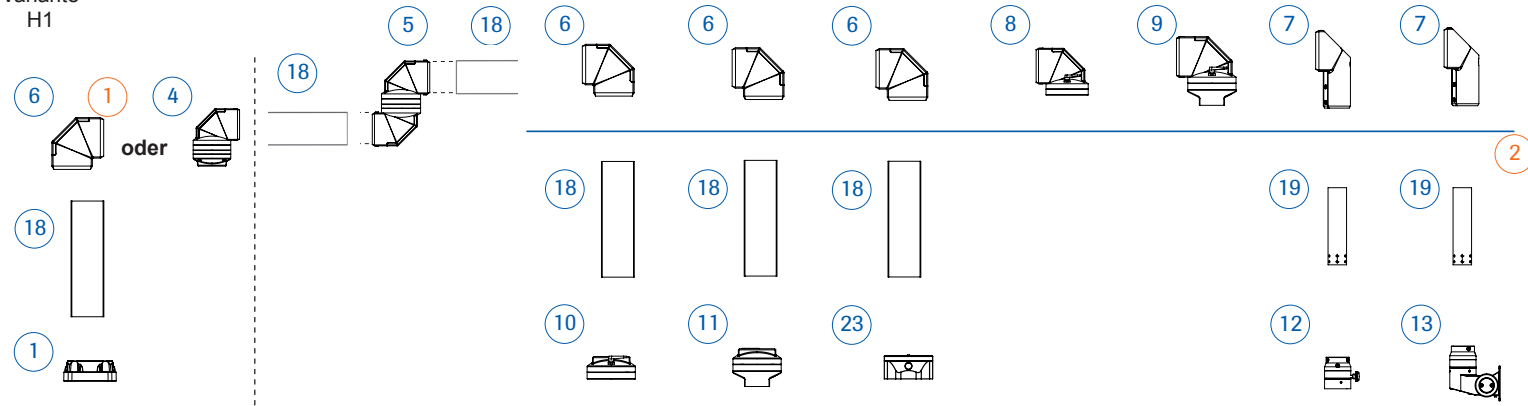

Variante H2

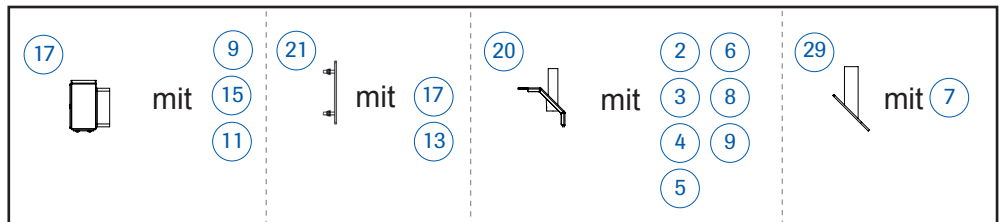

- ① **Achtung:** Bei Auswahl Winkel ⑥ kein Zwischengelenk ⑤ verwenden.
- ② **Achtung:** Alle Teile unter der Linie sind in die Traglast einzurechnen.
- ③ **Achtung:** Bei Verwendung Fachberatung notwendig.